



Cutlass LED - Wall Pack

Catalog Number	
Project	Type

FEATURES & SPECIFICATIONS

APPLICATION — The high performance luminaire is designed for full cutoff applications where long life, low maintenance, and consistent color rendering are required. Areas with limited accessibility due to fixture location or where heavy pedestrian traffic makes maintenance difficult are ideal applications such as building facade lighting or wall mounted security lighting. The contemporary design style of the luminaire allows it to be seamlessly integrated into existing systems when necessary.

CONSTRUCTION — The heavy duty housing is constructed of die cast aluminum. The optical assemblies are sealed in place using a silicone gasket for weather tight protection. IP66 rating available upon request.

FINISH — A Super Durable Polyester E-coat powder coat finish is electrostatically applied in our state of the art paint facility. Standard colors available: Black, Bronze, US Green, White. Custom colors available upon request.

OPTICAL SYSTEM — Made with a state of the art UV stabilized acrylic high performance refractive optical assemblies that use high transmittance materials to achieve precise photometric distributions. Available in Type II, III, and IV beam configurations. Star Light Friendly (meets or exceeds Dark Sky requirements) in the horizontal position.

ELECTRICAL SYSTEM — Available in a high output LED system in 5000K Cool White (+/- 500K), 4000K Neutral White or 3000K Warm White color. Available with 90-300V 50/60 Hz Class II power supply. LED's rated for over 100,000 hours at 55°C ambient temperature. Available with 120-277V 50/60 Hz power supply. 480V and 347V input option. Built-in surge protection up to 6 kV. Built-in Active PFC Function LED driver conforms to UL8750 standards.



SERIES	LENGTH HEIGHT & WIDTH
CTLW 1	11.54" x 6.12" x 7.46"

MOUNTING — Quick mount bracket connects to a standard J-Box. The bracket has a unique hanging feature to allow easy wire connections. After connections are made, the fixture swings down and is secured with two retaining screws at the bottom of the fixture.

LISTINGS — LED Driver listed for wet locations. LED bricks ETL listed for wet locations. Meets US and Canadian safety standards. -40°C to 50°C ambient operation.

ORDERING INFORMATION

Choose the bold face options for the appropriate luminaire configuration for your application and enter on the line above each fixture attribute. Accessories may be factory installed, depending on the particular accessory chosen, but still be ordered as a separate line item.

EXAMPLE:

CTLW 1 N 8L T4 1 BZ SCE

CTLW 1						
SERIES	COLOR TEMP/CCT	NOMINAL LUMENS ⁸	OPTICS	VOLTAGE	FINISH	OPTIONS
	C = Cool White (5000K) N = Neutral White (4000K) W = Warm White (3000K)	2L = 2,000 Lumens 3L = 3,000 Lumens 4L = 4,000 Lumens 5L = 5,000 Lumens 6L = 6,000 Lumens 7L = 7,000 Lumens 8L = 8,000 Lumens 9L = 9,000 Lumens 10L⁹ = 10,000 Lumens	T2 = Type II T3 = Type III T4 = Type IV	1 = Multi-Volt ¹ 2 = 347-480V ⁶	BZ = Bronze BK = Black GR = US Green WH = White SP = Special ²	SCE = Side Conduit Entry (2 x 3/4"-14 NPS Conduit) BDS8 = Bird-deterrent spikes PC3⁵ = Button Type Photocell 208-277V (1200W) P1000PC⁵ = Button Type Photocell 120V (1000W) HOEB⁶ = LED Battery Pack, 90 min IMS³ = Fixture Mount Passive Infrared Motion Sensor (IMS Lenses Below, Ordered Separately) TLWFSFP-L2⁴ = 360° lens, maximum coverage 48' diameter from 8' height (IMS) TLWFSFP-L3⁴ = 360° lens, maximum coverage 40' diameter from 20' height (IMS) IMSBTM⁷ = AC Powered Internal Network Wireless PIR & Daylight Harvesting Sensor. IMSBTM not available with HOEB option. (IMSBTM Lenses Below, Ordered as a Separate Line Item) WHBL1⁷ = 360° PIR lens, maximum coverage 80' dia. from 40' height (IMSBTM)

ACCESSORIES (Order as separate line items)

TLWFSIR-100 Remote Handheld Sensor Configuration Tool (For IMS Option)



NOTES

- 1 = Multi-Volt is an auto ranging power supply from 100V to 300V input.
- 2 = Custom RAL color matching is available. Contact your sales representative for additional info.
- 3 = TLWFSFP-L3 or L7 Lens must be ordered along with this sensor.
- 4 = Photo control shield available upon request. Lens must be ordered with IMS option.
- 5 = P1000PC operates at 120V and PC3 operates at 208-277V only.
- 6 = If selecting the HOEB option alongside the IMS option, the IMS sensor will be 'externally mounted' outside of the fixture. IMSBTM not available with HOEB option.
- 7 = WHBL1 Lens must be ordered along with the IMSBTM sensor.
- 8 = 347-480V input available in 6L, 8L, and 10L ONLY.
- 9 = Reference Lumen Chart to identify CCT and Optic Type availability for 10L module. Some combinations may deviate from ordering logic shown above.



CTLW 1 Cutlass LED - Wall Pack

LUMINAIRE CHARACTERISTICS

AVAILABLE FIXTURE DIMENSIONS

Cool White - 5000K

Output ID	Nominal Lumens	TYPE II			TYPE III			TYPE IV		
		System Lumens	System Watts	Lm/W	System Lumens	System Watts	Lm/W	System Lumens	System Watts	Lm/W
		BUG Rating			BUG Rating			BUG Rating		
2L	2,000	2,034	14	145	2,032	14	145	2,111	17	151
Bug Rating		B1-U0-G1			B0-U0-G1			B1-U0-G0		
3L	3,000	3,110	23	135	3,106	23	135	2,857	20	143
Bug Rating		B1-U0-G1			B1-U0-G1			B1-U0-G1		
4L	4,000	4,171	32	130	4,166	32	130	3,964	29	137
Bug Rating		B1-U0-G1			B1-U0-G1			B1-U0-G1		
5L	5,000	4,982	36	138	4,911	36	136	4,917	34	145
Bug Rating		B1-U0-G1			B1-U0-G1			B1-U0-G1		
6L	6,000	6,077	45	135	5,990	45	133	6,064	43	141
Bug Rating		B1-U0-G1			B1-U0-G1			B1-U0-G1		
7L	7,000	6,889	52	133	7,056	54	131	6,916	50	138
Bug Rating		B1-U0-G1			B1-U0-G2			B2-U0-G1		
8L	8,000	7,961	61	131	8,109	63	129	8,039	59	136
Bug Rating		B1-U0-G1			B1-U0-G2			B2-U0-G2		
9L	9,000	9,020	71	127	8,890	71	125	8,872	66	134
Bug Rating		B1-U0-G1			B1-U0-G2			B2-U0-G2		
10L	10,000	-	-	-	-	-	-	9,698	73	133
Bug Rating		-			-			B2-U0-G2		

Neutral White - 4000K

Output ID	Nominal Lumens	TYPE II			TYPE III			TYPE IV		
		System Lumens	System Watts	Lm/W	System Lumens	System Watts	Lm/W	System Lumens	System Watts	Lm/W
		BUG Rating			BUG Rating			BUG Rating		
2L	2,000	2,034	14	145	2,032	14	145	2,111	14	151
Bug Rating		B1-U0-G1			B0-U0-G1			B1-U0-G0		
3L	3,000	3,110	14	145	3,106	23	135	2,857	20	143
Bug Rating		B1-U0-G1			B1-U0-G1			B1-U0-G1		
4L	4,000	4,171	32	130	4,166	32	130	3,964	29	137
Bug Rating		B1-U0-G1			B1-U0-G1			B1-U0-G1		
5L	5,000	4,982	36	138	4,911	36	136	4,917	34	145
Bug Rating		B1-U0-G1			B1-U0-G1			B1-U0-G1		
6L	6,000	6,077	45	135	5,990	45	133	6,064	43	141
Bug Rating		B1-U0-G1			B1-U0-G1			B1-U0-G1		
7L	7,000	6,889	52	133	7,056	54	131	6,916	50	138
Bug Rating		B1-U0-G1			B1-U0-G2			B2-U0-G1		
8L	8,000	7,961	61	131	8,109	63	129	8,039	59	136
Bug Rating		B1-U0-G1			B1-U0-G2			B2-U0-G2		
9L	9,000	9,020	71	127	8,890	71	125	8,872	66	134
Bug Rating		B2-U0-G1			B1-U0-G2			B2-U0-G2		
10L	10,000	-	-	-	-	-	-	9,698	73	133
Bug Rating		-			-			B2-U0-G2		

Warm White - 3000K

Output ID	Nominal Lumens	TYPE II			TYPE III			TYPE IV		
		System Lumens	System Watts	Lm/W	System Lumens	System Watts	Lm/W	System Lumens	System Watts	Lm/W
		BUG Rating			BUG Rating			BUG Rating		
2L	2,000	1,932	14	138	1,930	14	138	2,006	14	143
Bug Rating		B1-U0-G1			B0-U0-G1			B1-U0-G0		
3L	3,000	2,954	23	128	2,951	23	128	3,066	23	133
Bug Rating		B1-U0-G1			B1-U0-G1			B1-U0-G1		
4L	4,000	3,963	32	124	3,958	32	124	4,113	32	129
Bug Rating		B1-U0-G1			B1-U0-G1			B1-U0-G1		
5L	5,000	4,733	36	132	4,665	36	130	4,671	34	137
Bug Rating		B1-U0-G1			B1-U0-G1			B1-U0-G1		
6L	6,000	5,773	45	128	5,690	45	126	5,761	43	134
Bug Rating		B1-U0-G1			B1-U0-G1			B1-U0-G1		
7L	7,000	6,545	52	126	6,703	54	124	6,570	50	131
Bug Rating		B1-U0-G1			B1-U0-G2			B2-U0-G1		
8L	8,000	7,563	61	124	7,703	63	122	7,637	59	129
Bug Rating		B1-U0-G1			B1-U0-G2			B2-U0-G2		
9L	9,000	8,569	71	121	8,446	71	119	8,953	71	126
Bug Rating		B2-U0-G1			B1-U0-G2			B2-U0-G2		
10L	10,000	-	-	-	-	-	-	-	-	-
Bug Rating		-			-			-		

Dimensions shown are for fixture bodies only. Mounting options must be ordered separately.

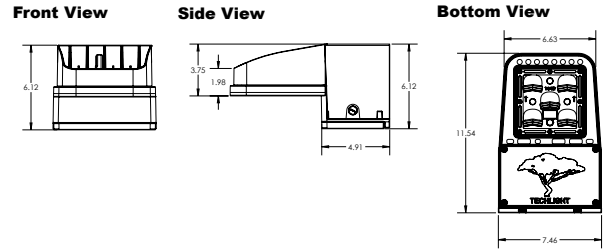

ADDITIONAL FIXTURE OPTIONS & ACCESSORIES

BDS8
Bird-Deterrent Spikes

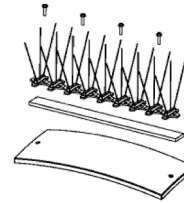

P1000PC
Button-Type Photocell



LED's rated for over 50,000 hours at 25°C ambient temperature.



- = 347-480V Not Available

System Wattage	L70 @ 25°C	Amperage Draw					
		120V	208V	240V	277V	347V	480V
17	>100K	0.14	0.08	0.07	0.06	-	-
26	>100K	0.22	0.13	0.11	0.09	-	-
30	>100K	0.25	0.15	0.13	0.11	-	-
35	>100K	0.29	0.17	0.14	0.13	-	-
37	>100K	0.31	0.18	0.15	0.13	0.11	0.08
39	>100K	0.32	0.19	0.16	0.14	0.11	0.08
42	>100K	0.35	0.20	0.18	0.15	0.12	0.09
47	>100K	0.39	0.22	0.19	0.17	0.13	0.10
53	>100K	0.44	0.25	0.22	0.19	0.15	0.11
59	>100K	0.49	0.28	0.25	0.21	0.17	0.12
65	>100K	0.54	0.31	0.27	0.24	0.19	0.14
71	>100K	0.60	0.34	0.30	0.26	0.21	0.15
78	>100K	0.65	0.37	0.32	0.28	0.22	0.16



TECHLIGHT
GROUNDED IN ILLUMINATION

2707 SATSUMA | DR. DALLAS, TX 75229 | PH: 800.225.0727 | www.techlight.com

All dimensions and specifications are subject to change without notice.

REV: 20240506-05

CTLW 1 Cutlass LED - Wall Pack

Integral Motion Sensor Blue Tooth Module (IMSBTM)

APPLICATION — The IMSBTM is an AC-powered, Integral Motion Sensor Blue Tooth Module, that is highly versatile for various indoor and outdoor lighting fixtures. It provides **360° coverage**, making it optimal for open spaces and aiseways. This sensor is particularly suitable for environments such as parking lots, fuel stations, walkways, and storage facilities. The WHBL1 lens is crafted for fixtures at mounting heights ranging from **20 to 40 feet**, ensuring a coverage span of up to **80 feet in diameter** at the maximum height of **40 feet**. These lenses are designed with multiple cells and tiers, creating a dense pattern of coverage.

- Analog Sensor Built-in
- Replaceable lens options
- 120-277V Line Voltage input
- Daylight harvesting available

OPERATION — Typically, the sensor ramps lighting On to the selected High mode level when motion is detected and the ambient light level is below the hold off setpoint. After the sensor stops detecting movement and the time delay elapses, lights fade to the Low mode level. If there is no motion during the subsequent cut off time delay, the lights will turn Off. For dusk to dawn control, the integral photocell can switch the lights On and Off based on the ambient light level so that lighting remains on overnight even without motion detection.

ADDITIONAL FEATURES

- **Wireless Control System:** Bluetooth® Low Energy Mesh 4.2 & 5.0 protocols. Enables individual or group control of luminaires.
- **Mobile App Operation:** Intuitive interface for easy management.
- **Flexible Commissioning:** Components commissioned via the Mobile App. No need for a gateway during commissioning.
- **Sensor Integration:** Works seamlessly with various sensors. Enhances energy efficiency and responsive lighting.
- **Mesh Network Range:** Wireless communication up to 100 feet or more between devices. Ideal for diverse spatial configurations.
- **Internet Independence:** Commissioning and operation without internet access. Ensures functionality in various environments.
- **Security Measures:** Data encryption for mesh network security. Device access restricted without encrypted QR codes.
- **UL 1376 Verification:** LiteTrace, the manufacturer, has UL 1376 verification. Ensures adherence to stringent security standards.
- **In-House R&D Capabilities:** Full-stack, in-house R&D for networked sensors and controllers. Reflects a high level of control and innovation.
- **Industry Recognition:** One of the first systems listed to DLC's Networked Lighting Controls (NLC5). Compliance with industry standards and specifications.

SENSOR LENS FIELD OF VIEW AND DIMENSIONS

Note = WHBL1 Lens must be ordered along with the IMSBTM sensor.

WHBL1

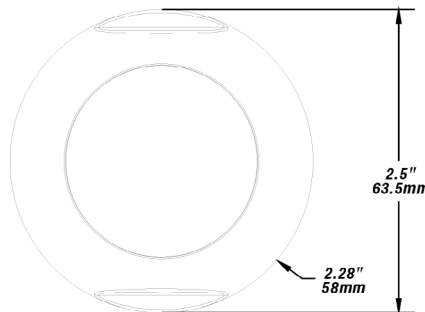

Coverage Side View

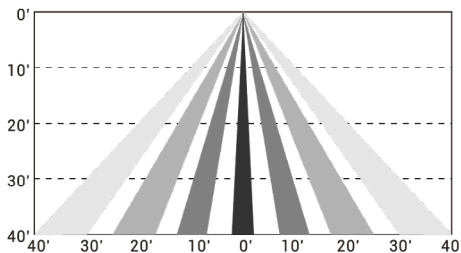

Coverage Top View

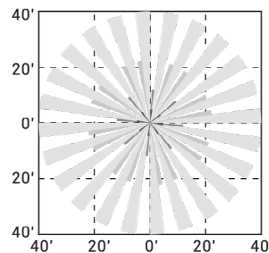

Detecting Spots For Ref

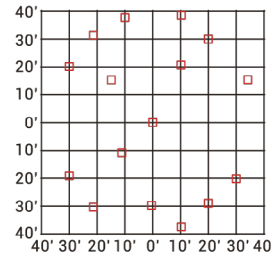

Network Lighting Control App Instruction Manual

located on the Techlight Website -> Resources Page.
Location shown below, or scan the QR code to the right.
<https://techlight.com/pdf/IMSBTM%20Manual.pdf>



CTLW 1 Cutlass LED - Wall Pack

FIXTURE MOUNT SENSOR (IMS)

FEATURES & SPECIFICATIONS

APPLICATION — The sensor is ideal for areas such as parking facilities, gas stations, pedestrian pathways, and warehouses. A choice of four lenses ensures complete coverage for mounting heights up to 40'.

OPERATION — Typically, the sensor ramps lighting On to the selected High mode level when motion is detected and the ambient light level is below the hold off setpoint. After the sensor stops detecting movement and the time delay elapses, lights fade to the Low mode level. If there is no motion during the subsequent cut off time delay, the lights will turn Off. For dusk to dawn control, the integral photocell can switch the lights On and Off based on the ambient light level so that lighting remains on overnight even without motion detection.

FEATURES —

- Provides line voltage On/Off switching
- High and low modes fully adjustable from 0 to 10V
- Time delay from 5 to 30 minutes
- Optional cut off delay
- Adjustable ramp up and fade down times
- Optional daylighting setpoints feature automatic calibration, or permit manual adjustment
- Polycarbonate construction; flame retardant, UV resistant, impact resistant, recyclable

TLWSFSIR-100 Remote Handheld Sensor Configuration Tool



SENSOR LENSES FIELD OF VIEW

4 = Photo control shield available upon request. Lens must be ordered with IMS option.

TLWSFSP-L2⁴

360° lens, maximum coverage 48' diameter from 8' height

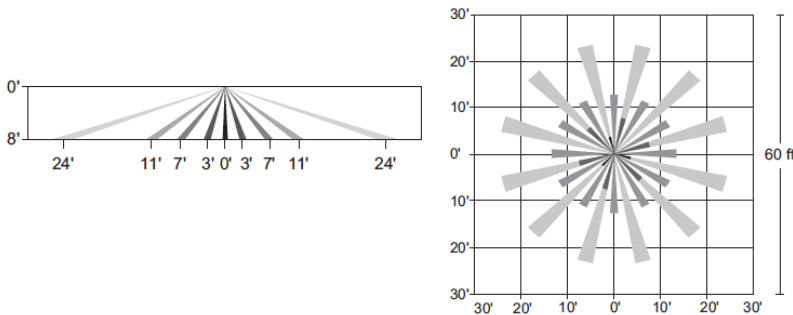

TLWSFSP-L3⁴

360° lens, maximum coverage 40' diameter from 20' height

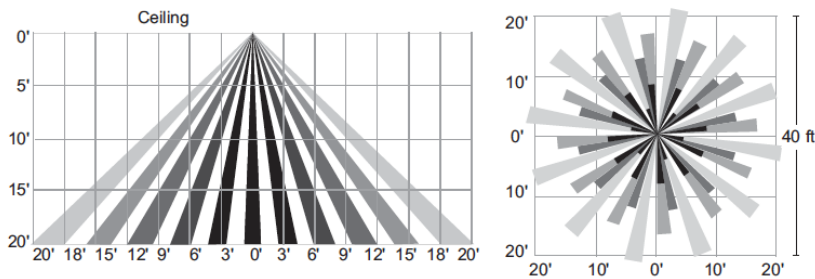

WARNING: Maintenance performed including the replacement of LED bricks while power is still supplied to the luminaire may result in system failures and will void the warranty



2707 SATSUMA | DR. DALLAS, TX 75229 | PH: 800.225.0727 | www.techlight.com